

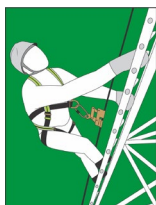

Ex II2 G Exh IIC T6 Gb

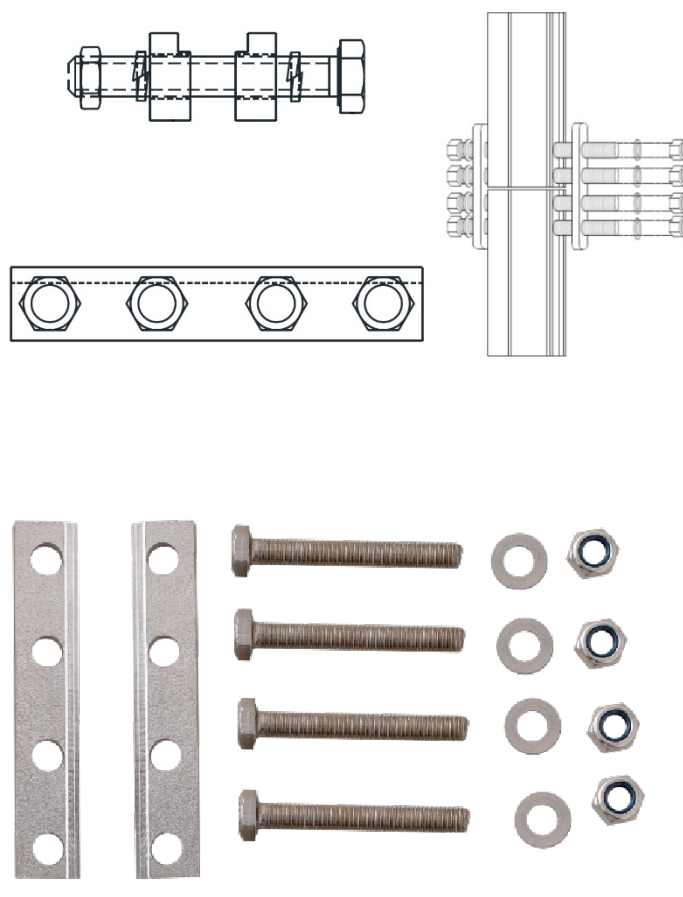

HS CODE

73269099

CARTON SIZE / PCS.

40 x 30 x 15 / 100

AET N°2777/10981-01/E01-01





Satra Technology Europe Ltd., N° 2777,
Bracetown Business Park, Clonee,
Dublin, D15YN2P, Ireland

MODULE D F114/14003.02

SGS Fimko Oy, N°0598
Takomotie 8,
00380 HELSINKI, Finland

ACKNOWLEDGEMENT OF RECEIPT N°3974/1/2018 (ATEX)

Technická Inšpekcia, a.s. N°1354
Trnavská cesta 56, 821 01 Bratislava, Slovenská Republika

REF.	FA 20 704 00
 LG. KG	--- ----- MAX. 100 KG
	EN 353-1, Directive ATEX
MAT.	
R >	15 kN
+	ATEX directive 2014/34/UE ( II 2 G Exh IIC T6 Gb).
	1.16 KG



Longueur Poids maxi utilisateur
Length Max. user weight
Longitud Peso máximo del usuario
Lunghezza Peso Max. dell'utente
Länge Höchstgewicht des Benutzers

R(kN)

Résistance (en kN)
 Resistance (kN)
Resistencia (en kN)
 Resistenza
Belastbarkeit (in kN)